

INSTRUCTIONS FOR INSTALLATION

# Kabe Ramp Frame

## Ramp Frame- Type 1

The Kabe Ramp Frame type 1 is supplied mounted on the Kabe Mat Original from our factory. Just roll out the mat and the installation is ready.

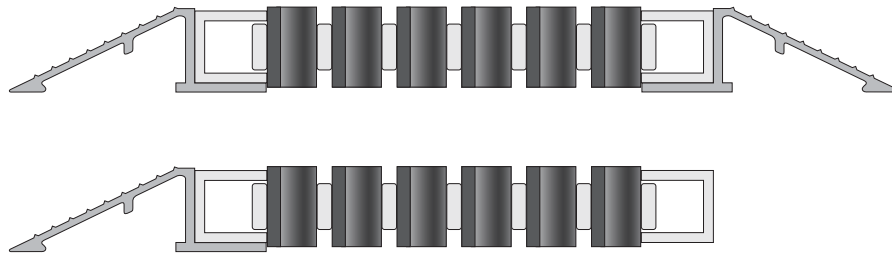

## Ramp Frame- Type 2

Kabe Ramp Frame is supplied in loose lengths made to measurements with 45° corners. Insert the connectors in the profile as shown on the sketch and tap gently with a rubber hammer if needed.

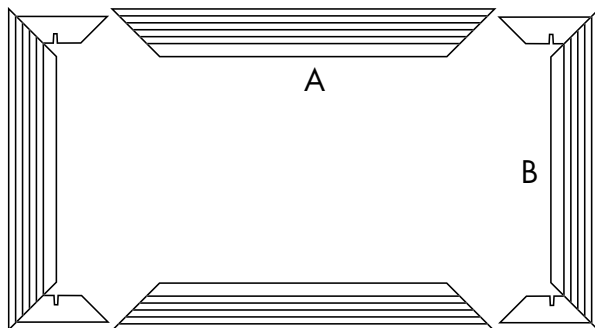

A side = width  
B side = path

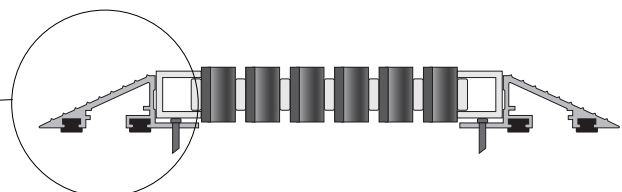
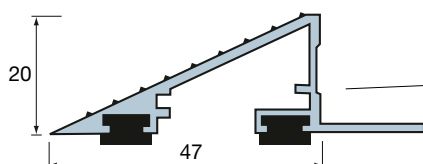

## INSTRUCTIONS FOR INSTALLATION

### Ramp Frame- Type 2

1. Fit the angle straight in the frame, marked side facing upwards.

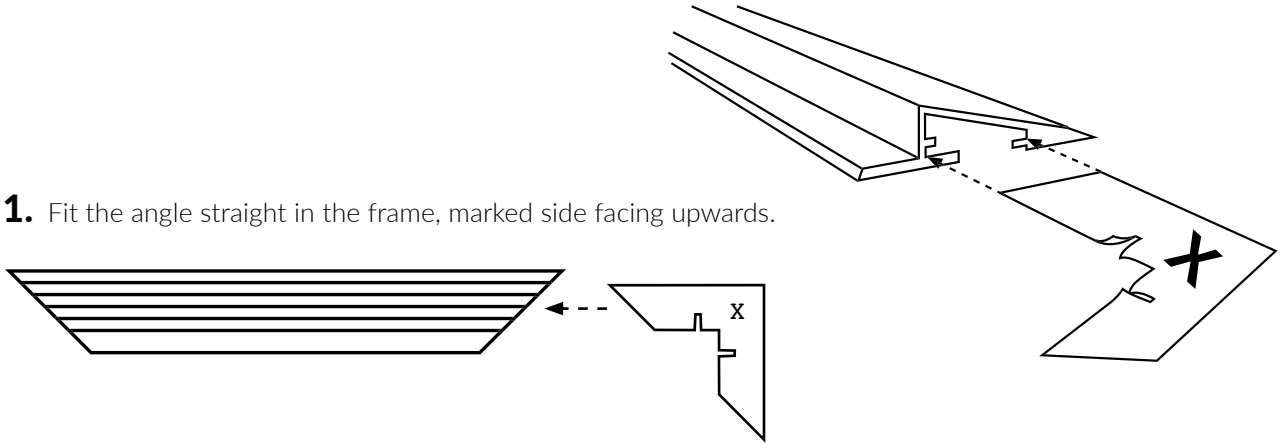

2. Carefully tap in the angle brackets. Use a rubber mallet or hammer with a wooden block (which acts as spacer).

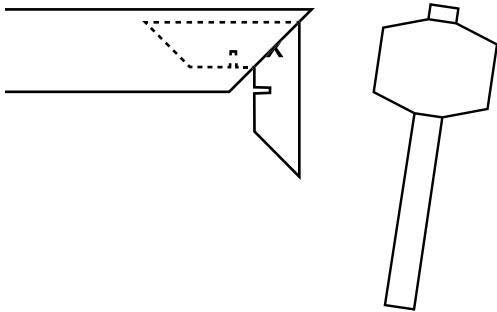

3. Place the A sides & fit the B sides by sliding both corners together. Use a rubber mallet or hammer with a wooden block (which acts as spacer).

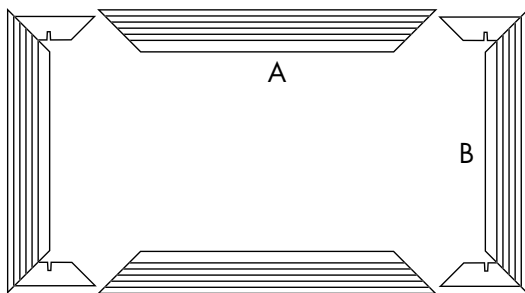

A side = width  
B side = path